

**exporlux.**  
**PISO.**



*I'm*  
**TOUCH  
ABLE**

# PISO EN.

A gama PISO é uma sucessão de produtos de exterior com diferentes diâmetros, capazes de harmonizar qualquer espaço na sua simplicidade ou na sua verde exuberância, consegue tornar a arquitetura edílica, o ambiente encantador, onde as pessoas sentem que o lugar é cativante e agradável de estar.

**Montagem Encastrada**  
Corpo em Alumínio Injetado com pintura electrostática  
Aro em Aço INOX AISI 316 Escovado  
Difusor em vidro temperado transparente

The PISO range is a succession of exterior products with different diameters, able to harmonize any space in its simplicity or in its green exuberance. It can make the edile architecture, the charming environment, where people feel that the place is captivating and pleasant to be.

**Recessed Mount**  
Injected Aluminum body with electrostatic paint  
Brushed AISI 316 STAINLESS STEEL rim  
Clear tempered glass diffuser

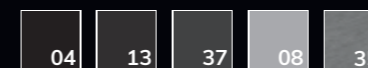

■ outros cores ou acabamentos disponíveis a pedido  
other colors or finishes available under request

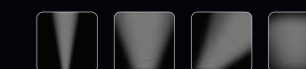

\* opção sob consulta under request

Piso PV 282

Piso PV 233

Piso PV 175

Piso PV 110

# PISO EN 110

	DIMENSÕES DIMENSIONS	ALIMENTAÇÃO SUPPLY	LUMENS LUMENS	POTÊNCIA WATTS	IRC CRI	TCC(K) CCT(K)	ÂNGULO BEAM ANGLE
DOB PV	Ø110x133	230V AC 50Hz	438 - 533	8W	70	3000 - 4000	12°   32°   40°
L PV	Ø110x133	230V AC 50Hz	238 - 251	4W	70	3000 - 4000	8°
PV	Ø110x133	230V AC 50Hz	-	GU10 PAR16 max. 6W	-	-	-
DOB PV	110x110x133	230V AC 50Hz	438 - 533	8W	70	3000 - 4000	12°   32°   40°
L PV	110x110x133	230V AC 50Hz	238 - 251	4W	70	3000 - 4000	8°
PV	110x110x133	230V AC 50Hz	-	GU10 PAR16 max. 6W	-	-	-
DOB TE	Ø110x133	230V AC 50Hz	438 - 533	8W	70	3000 - 4000	12°   32°   40°
L TE	Ø110x133	230V AC 50Hz	238 - 251	4W	70	3000 - 4000	8°
TE	Ø110x133	230V AC 50Hz	-	GU10 PAR16 max. 6W	-	-	-

■ Valores nominais à temperatura ambiente (Ta=25°), e de acordo com EN60598 e EN 13032-1. Dadas as tolerâncias nos materiais, os dados de fluxo luminoso e consumo eléctrico têm uma tolerância de +/-10%.  
 Versões PISO PV EN - encastrar no solo com recurso a caixa de chumbar. Versões PISO TE EN - encastrar em tecto falso  
 \*sob consulta  
 Nominal values at room temperature (Ta=25°) and according to EN60598 and EN 13032-1. Given the tolerances on materials, the luminous flux and electrical consumption data have a tolerance of +/-10%.  
 PISO PV EN versions - recessed into the ground using a recessing box. PISO TE EN versions - recessed in false ceiling  
 \*on request

PISO PV EN Ø110

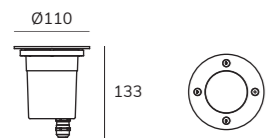

PISO PV EN 110

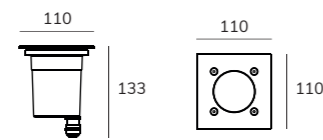

PISO TE EN Ø110

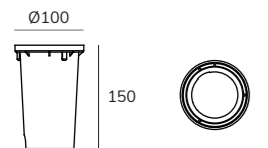
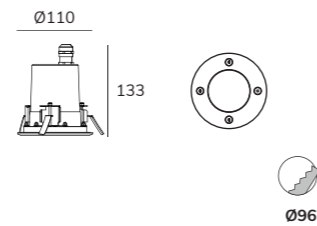

acessório CAIXA DE ENCASTRAR  
 accessory RECESSING BOX



■ medidas em mm  
 measured in mm



PISO DOB PV EN Ø110

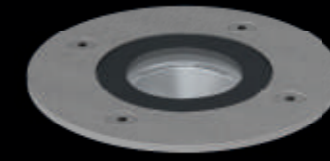

PISO DOB PV EN Ø110

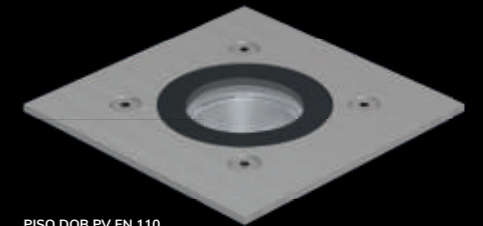

PISO DOB PV EN 110

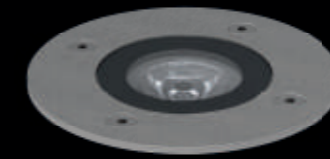

PISO L PV EN Ø110



PISO DOB TE EN Ø110

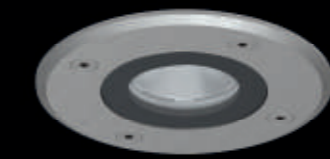

PISO DOB TE EN Ø110



PISO L TE EN Ø110



■ outras cores ou acabamentos disponíveis a pedido.  
 versões TE apenas.  
 other colors or finishes available under request.  
 TE versions only.

# PISO EN 175

	DIMENSÕES DIMENSIONS	ALIMENTAÇÃO SUPPLY	LUMENS LUMENS	POTÊNCIA WATTS	IRC CRI	TCC (K) CCT (K)	ÂNGULO BEAM ANGLE
DOB PV	Ø175x141	230V AC 50Hz	1395 - 1526	14W	70	3000 - 4000	30°   43°   67°
L PV	Ø175x141	230V AC 50Hz	644 - 692	10W	70	3000 - 4000	13°   16°   33°
DOB PV	175x175x141	230V AC 50Hz	1395 - 1526	14W	70	3000 - 4000	30°   43°   67°
L PV	175x175x141	230V AC 50Hz	644 - 692	10W	70	3000 - 4000	13°   16°   33°
DOB TE	Ø175x141	230V AC 50Hz	1395 - 1526	14W	70	3000 - 4000	30°   43°   67°
L TE	Ø175x141	230V AC 50Hz	644 - 692	10W	70	3000 - 4000	13°   16°   33°

■ Valores nominais à temperatura ambiente (Ta=25°), e de acordo com EN60598 e EN 13032-1. Dados as tolerâncias nos materiais, os dados de fluxo luminoso e consumo eléctrico têm uma tolerância de +/-10%.  
 Versões PISO PV EN - encastrar no solo com recurso a caixa de chumbar. Versões PISO TE EN - encastrar em tecto falso  
 \*sob consulta  
 Nominal values at room temperature (Ta=25°) and according to EN60598 and EN 13032-1. Given the tolerances on materials, the luminous flux and electrical consumption data have a tolerance of +/-10%.  
 PISO PV EN versions - recessed into the ground using a recessing box. PISO TE EN versions - recessed in false ceiling  
 \*on request

PISO PV EN Ø175

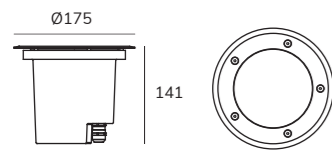

PISO PV EN 175

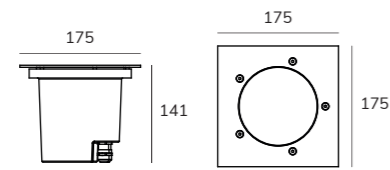

PISO TE EN Ø175

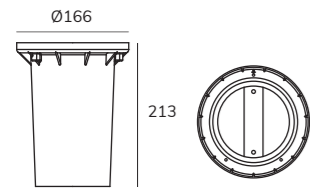
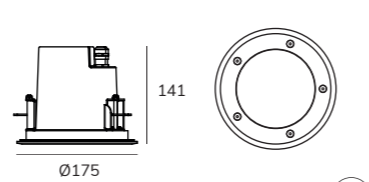

acessório CAIXA DE ENCASTRAR  
 accessory RECESSING BOX

■ medidas em mm  
 measured in mm



PISO DOB PV EN Ø175

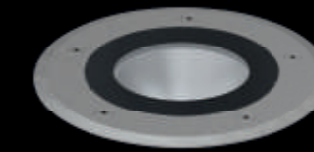

PISO DOB PV EN Ø175

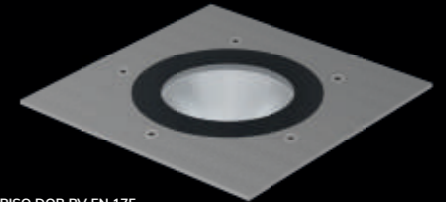

PISO DOB PV EN 175



PISO L PV EN Ø175



PISO DOB TE EN Ø175

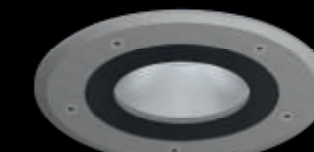

PISO DOB TE EN Ø175



PISO L TE EN Ø175



■ outras cores ou acabamentos disponíveis a pedido.  
 versões TE apenas.  
 other colors or finishes available under request.  
 TE versions only.

# PISO EN 233

	DIMENSÕES DIMENSIONS	ALIMENTAÇÃO SUPPLY	LUMENS LUMENS	POTÊNCIA WATTS	IRC CRI	TCC (K) CCT (K)	ÂNGULO BEAM ANGLE
DOB PV	Ø233x172	230V AC 50Hz	2341 - 2713	28W	70	3000 - 4000	16°   49°   64°   ASS.
L PV	Ø233x172	230V AC 50Hz	644 - 1612	10W - 19W	70	3000 - 4000	13°   16°   33°
DOB PV	233x233x172	230V AC 50Hz	2341 - 2713	28W	70	3000 - 4000	16°   49°   64°   ASS.
L PV	233x233x172	230V AC 50Hz	644 - 1612	10W - 19W	70	3000 - 4000	13°   16°   33°
DOB TE	Ø233x172	230V AC 50Hz	2341 - 2713	28W	70	3000 - 4000	16°   49°   64°   ASS.
L TE	Ø233x172	230V AC 50Hz	644 - 1612	10W - 19W	70	3000 - 4000	13°   16°   33°

■ Valores nominais à temperatura ambiente (Ta=25°), e de acordo com EN60598 e EN 13032-1. Dados as tolerâncias nos materiais, os dados de fluxo luminoso e consumo eléctrico têm uma tolerância de +/-10%.  
 Versões PISO PV EN - encastrar no solo com recurso a caixa de chumbar. Versões PISO TE EN - encastrar em tecto falso  
 \*sob consulta  
 Nominal values at room temperature (Ta=25°) and according to EN60598 and EN 13032-1. Given the tolerances on materials, the luminous flux and electrical consumption data have a tolerance of +/-10%.  
 PISO PV EN versions - recessed into the ground using a recessing box. PISO TE EN versions - recessed in false ceiling  
 \*on request

PISO PV EN Ø233

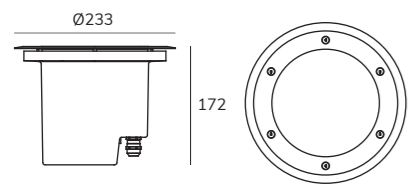

PISO PV EN 233

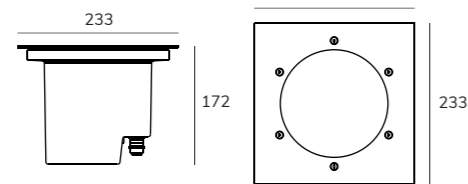

PISO TE EN Ø233

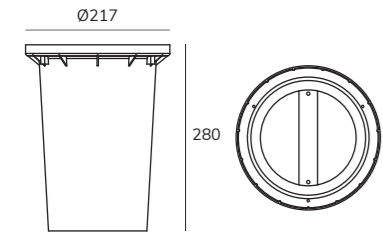
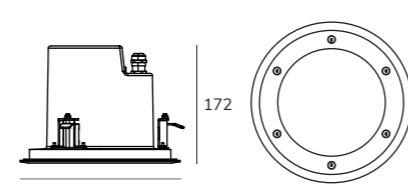

acessório CAIXA DE ENCASTRAR  
 accessory RECESSING BOX

■ medidas em mm  
 measured in mm

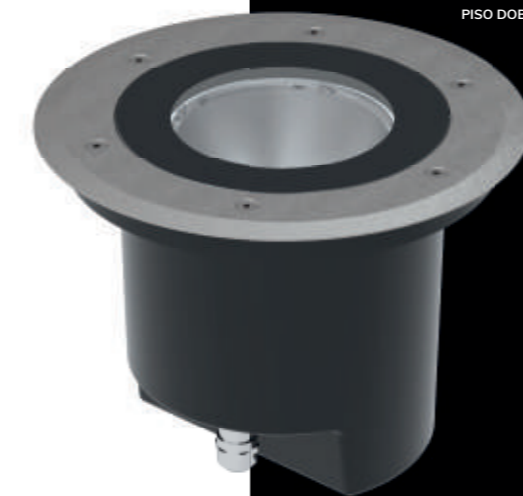

PISO DOB PV EN Ø233

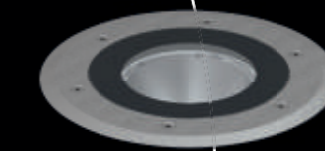

PISO DOB PV EN Ø233

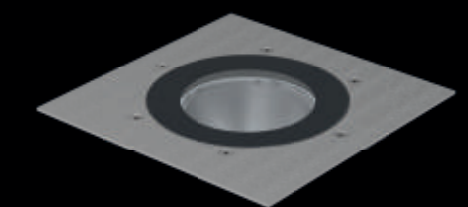

PISO DOB PV EN 233

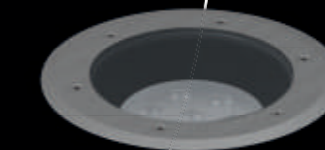

PISO L PV EN Ø233



PISO DOB TE EN Ø233

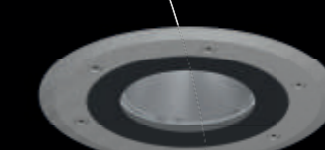

PISO DOB TE EN Ø233

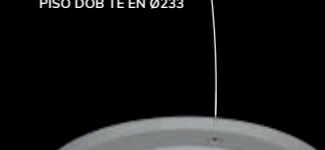



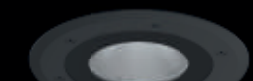

PISO L TE EN Ø233



■ outras cores ou acabamentos disponíveis a pedido.  
 versões TE apenas.  
 other colors or finishes available under request.  
 TE versions only.

# PISO EN 282

	DIMENSÕES DIMENSIONS	ALIMENTAÇÃO SUPPLY	LUMENS LUMENS	POTÊNCIA WATTS	IRC CRI	TCC <sup>(K)</sup> CCT <sup>(K)</sup>	ÂNGULO BEAM ANGLE
 DOB PV	Ø282x345	230V AC 50Hz	2837 - 3243	35W	70	3000 - 4000	15°   21°   38°   70°
 L PV	Ø282x345	230V AC 50Hz	644 - 1612	10W - 19W	70	3000 - 4000	13°   16°   33°
 DOB PV	282x282x345	230V AC 50Hz	2837 - 3243	35W	70	3000 - 4000	15°   21°   38°   70°
 L PV	282x282x345	230V AC 50Hz	644 - 1612	10W - 19W	70	3000 - 4000	13°   16°   33°

■ Valores nominais à temperatura ambiente (T<sub>a</sub>=25°), e de acordo com EN60598 e EN 13032-1. Dados as tolerâncias nos materiais, os dados de fluxo luminoso e consumo eléctrico têm uma tolerância de +/-10%.  
 Versões PISO PV EN - encastrar no solo com recurso a caixa de chumbar. Versões PISO TE EN - encastrar em tecto falso  
 \*sob consulta  
 Nominal values of room temperature (T<sub>a</sub>=25°) and according to EN60598 and EN 13032-1. Given the tolerances on materials, the luminous flux and electrical consumption data have a tolerance of +/-10%.  
 PISO PV EN versions - recessed into the ground using a recessing box. PISO TE EN versions - recessed in false ceiling  
 \*on request

PISO PV EN Ø282

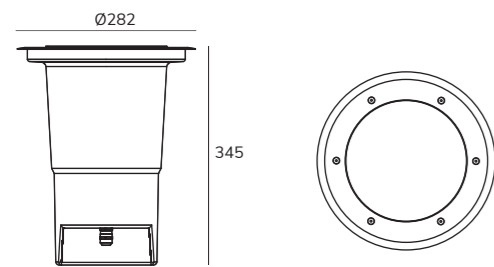

PISO PV EN 282

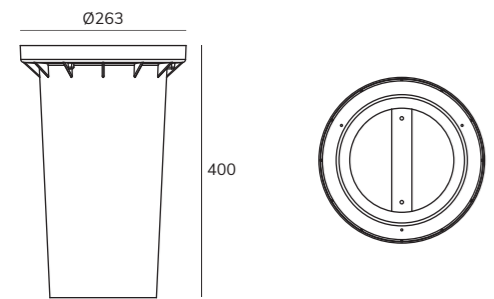
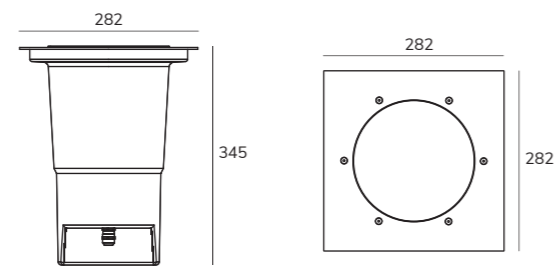

acessório CAIXA DE ENCASTRAR  
 accessory RECESSING BOX

■ medidas em mm  
 measured in mm

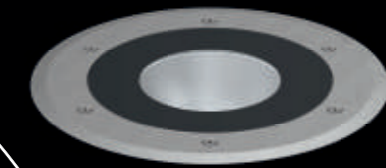

PISO DOB PV EN Ø282



PISO L PV EN Ø282

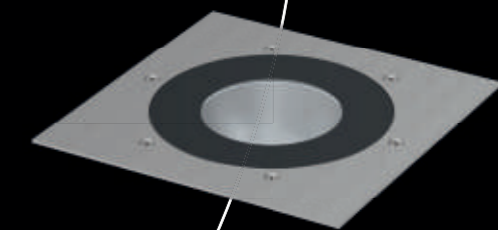

PISO DOB PV EN 282

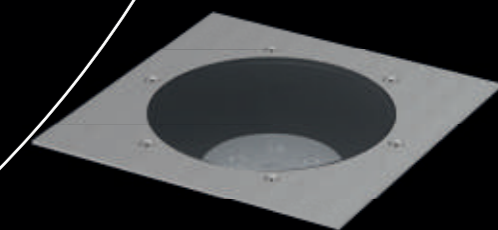

PISO L PV EN 282





PISO ES



**PISO BA/ES.**

Montagem saliente  
corpo em Alumínio Injetado com pintura eletroestática  
Aro em Aço INOX AISI 316 Escovado  
Difusor em vidro temperado transparente

Surface mount  
Injected aluminum body with electrostatic paint  
Stainless Steel Ring AISI 316 Brushed  
Clear tempered glass diffuser

35

■ outras cores ou acabamentos disponíveis a pedido  
other colors or finishes available under request



\* opção sob consulta under request

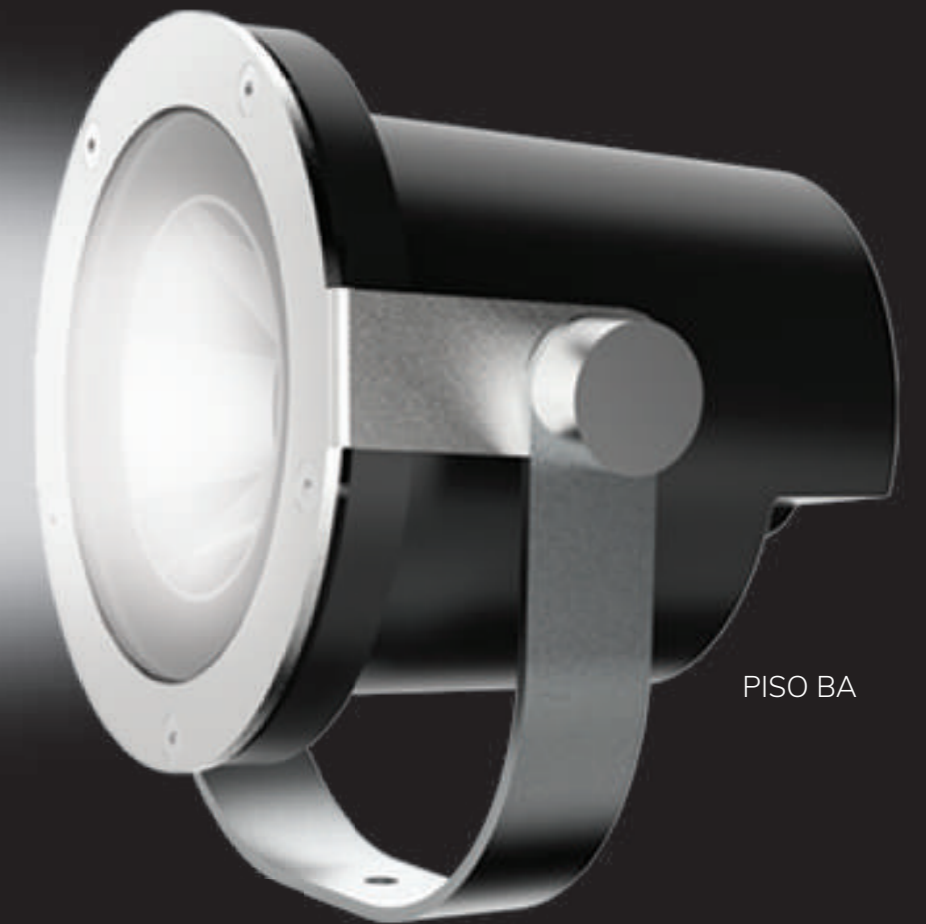

PISO BA

## PISO BA Ø100

	DIMENSÕES DIMENSIONS	ALIMENTAÇÃO SUPPLY	LUMENS LUMENS	POTÊNCIA WATTS	IRC CRI	TCC(K) CCT(K)	ÂNGULO BEAM ANGLE
DOB	100x119x153	230V AC 50Hz	438 - 533	8W	70	3000 - 4000	12°   32°   40°
L	100x119x153	230V AC 50Hz	238 - 251	4W	70	3000 - 4000	8°
GZ10 SLD	100x119x153	230V AC 50Hz	-	GU10 PAR16 max. 6W	-	-	-

■ Valores nominais à temperatura ambiente (Ta=25°), e de acordo com EN60598 e EN 13032-1. Dados as tolerâncias nos materiais, os dados de fluxo luminoso e consumo eléctrico têm uma tolerância de +/-10%.  
\*sob consulta  
Nominal values at room temperature (Ta=25°) and according to EN60598 and EN 13032-1. Given the tolerances on materials, the luminous flux and electrical consumption data have a tolerance of +/-10%.  
\*on request

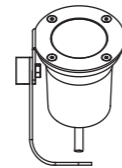

■ medidas em mm  
measured in mm

## PISO ES Ø100

	DIMENSÕES DIMENSIONS	ALIMENTAÇÃO SUPPLY	LUMENS LUMENS	POTÊNCIA WATTS	IRC CRI	TCC(K) CCT(K)	ÂNGULO BEAM ANGLE
DOB	100x119x300	230V AC 50Hz	438 - 533	8W	70	3000 - 4000	12°   32°   40°
L	100x119x300	230V AC 50Hz	238 - 251	4W	70	3000 - 4000	8°
GZ10 SLD	100x119x300	230V AC 50Hz	-	GU10 PAR16 max. 6W	-	-	-

■ Valores nominais à temperatura ambiente (Ta=25°), e de acordo com EN60598 e EN 13032-1. Dados as tolerâncias nos materiais, os dados de fluxo luminoso e consumo eléctrico têm uma tolerância de +/-10%.  
\*sob consulta  
Nominal values at room temperature (Ta=25°) and according to EN60598 and EN 13032-1. Given the tolerances on materials, the luminous flux and electrical consumption data have a tolerance of +/-10%.  
\*on request

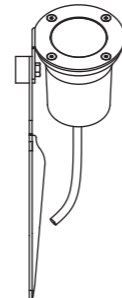
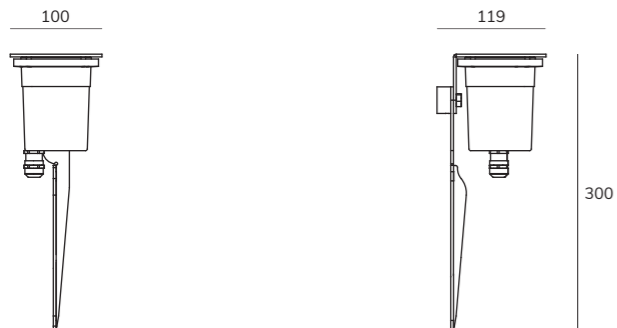

■ medidas em mm  
measured in mm



PISO DOB BA SLD Ø100



PISO L BA SLD Ø100





PISO DOB ES SLD Ø100



PISO L ES SLD Ø100

## PISO BA Ø151

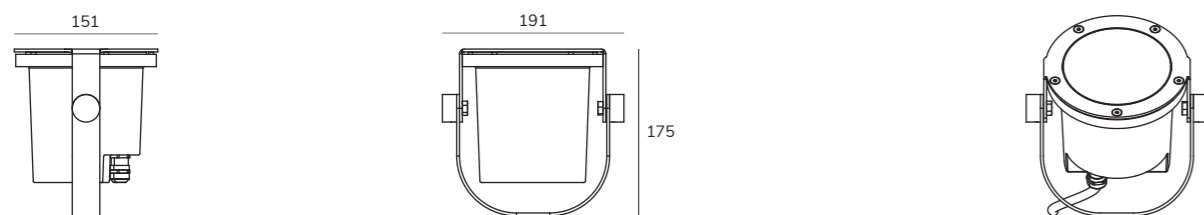

	DIMENSÕES DIMENSIONS	ALIMENTAÇÃO SUPPLY	LUMENS LUMENS	POTÊNCIA WATTS	IRC CRI	TCC (K) CCT (K)	ÂNGULO BEAM ANGLE
 <b>DOB</b>	151x191x175	230V AC 50Hz	1395 - 1526	14W	70	3000 - 4000	30°   43°   67°
 <b>L</b>	151x191x175	230V AC 50Hz	644 - 692	10W	70	3000 - 4000	13°   16°   33°

■ Valores nominais à temperatura ambiente (Ta=25°), e de acordo com EN60598 e EN 13032-1. Dados as tolerâncias nos materiais, os dados de fluxo luminoso e consumo eléctrico têm uma tolerância de +/-10%.  
\*sob consulta  
Nominal values at room temperature (Ta=25°) and according to EN60598 and EN 13032-1. Given the tolerances on materials, the luminous flux and electrical consumption data have a tolerance of +/-10%.  
\*on request



■ medidas em mm  
measured in mm

## PISO ES Ø151

	DIMENSÕES DIMENSIONS	ALIMENTAÇÃO SUPPLY	LUMENS LUMENS	POTÊNCIA WATTS	IRC CRI	TCC (K) CCT (K)	ÂNGULO BEAM ANGLE
 <b>DOB</b>	151x191x426	230V AC 50Hz	1395 - 1526	14W	70	3000 - 4000	30°   43°   67°
 <b>L</b>	151x191x426	230V AC 50Hz	644 - 692	10W	70	3000 - 4000	13°   16°   33°

■ Valores nominais à temperatura ambiente (Ta=25°), e de acordo com EN60598 e EN 13032-1. Dados as tolerâncias nos materiais, os dados de fluxo luminoso e consumo eléctrico têm uma tolerância de +/-10%.  
\*sob consulta  
Nominal values at room temperature (Ta=25°) and according to EN60598 and EN 13032-1. Given the tolerances on materials, the luminous flux and electrical consumption data have a tolerance of +/-10%.  
\*on request

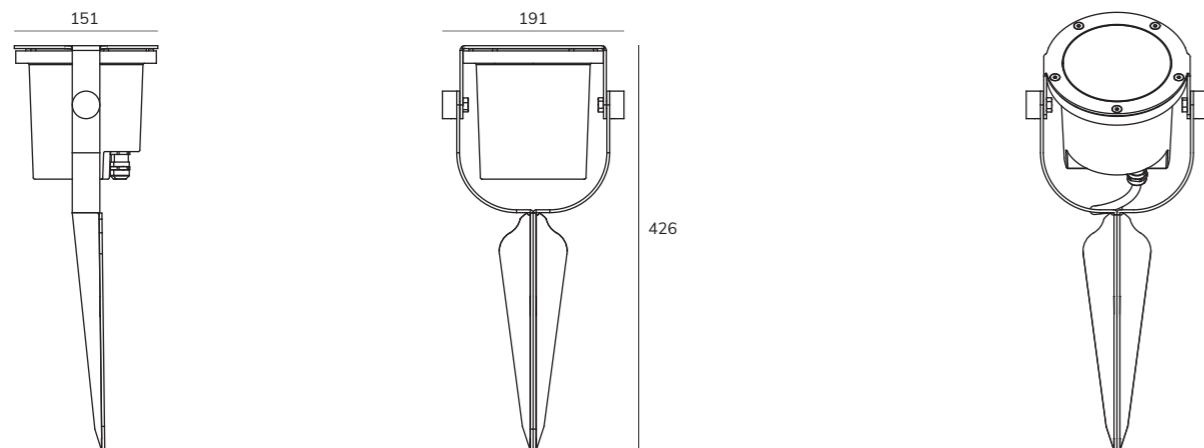

■ medidas em mm  
measured in mm

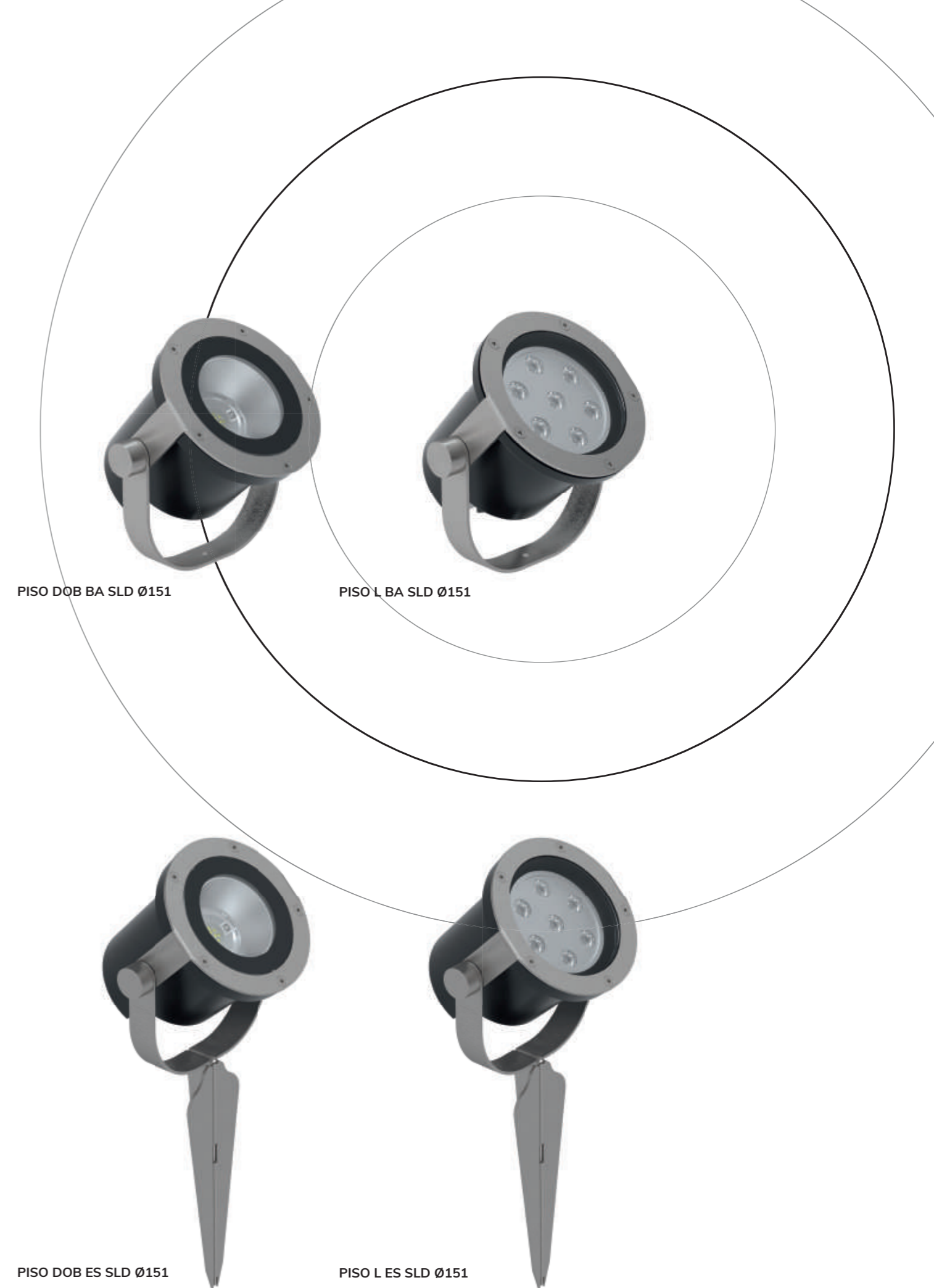



PISO DOB BA SLD Ø151

PISO L BA SLD Ø151

PISO DOB ES SLD Ø151

PISO L ES SLD Ø151

## PISO BA Ø215

	DIMENSÕES DIMENSIONS <small>mm</small>	ALIMENTAÇÃO SUPPLY	LUMENS LUMENS <small>lm</small>	POTÊNCIA WATTS <small>W</small>	IRC CRI	TCC (K) CCT (K)	ÂNGULO BEAM ANGLE <small>mm-max</small>
 DOB	215x256x204	230V AC 50Hz	2341 - 2713	28W	70	3000 - 4000	16°   49°   64°   ASS.
 L	215x256x204	230V AC 50Hz	644 - 1612	10W - 19W	70	3000 - 4000	13°   16°   33°

■ Valores nominais à temperatura ambiente (Ta=25°), e de acordo com EN60598 e EN 13032-1. Dados as tolerâncias nos materiais, os dados de fluxo luminoso e consumo eléctrico têm uma tolerância de +/-10%.  
 \*sob consulta  
 Nominal values at room temperature (Ta=25°) and according to EN60598 and EN 13032-1. Given the tolerances on materials, the luminous flux and electrical consumption data have a tolerance of +/-10%.  
 \*on request

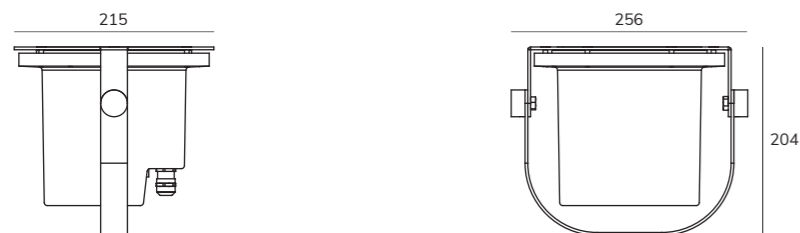



PISO DOB BA SLD Ø215

PISO L BA SLD Ø215

■ medidas em mm  
measured in mm

## PISO ES Ø215

	DIMENSÕES DIMENSIONS <small>mm</small>	ALIMENTAÇÃO SUPPLY	LUMENS LUMENS <small>lm</small>	POTÊNCIA WATTS <small>W</small>	IRC CRI	TCC (K) CCT (K)	ÂNGULO BEAM ANGLE <small>mm-max</small>
 DOB	215x256x456,5	230V AC 50Hz	2341 - 2713	28W	70	3000 - 4000	16°   49°   64°   ASS.
 L	215x256x456,5	230V AC 50Hz	644 - 1612	10W - 19W	70	3000 - 4000	13°   16°   33°

■ Valores nominais à temperatura ambiente (Ta=25°), e de acordo com EN60598 e EN 13032-1. Dados as tolerâncias nos materiais, os dados de fluxo luminoso e consumo eléctrico têm uma tolerância de +/-10%.  
 \*sob consulta  
 Nominal values at room temperature (Ta=25°) and according to EN60598 and EN 13032-1. Given the tolerances on materials, the luminous flux and electrical consumption data have a tolerance of +/-10%.  
 \*on request

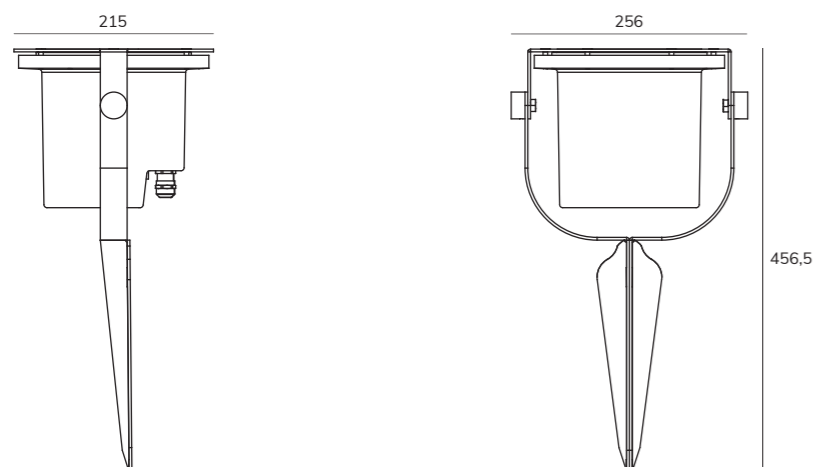

PISO DOB ES SLD Ø215

PISO L ES SLD Ø215

■ medidas em mm  
measured in mm



## CONDIÇÕES GERAIS | GENERAL CONDITIONS

### INSTALAÇÃO E MANUTENÇÃO

A Exporlux sugere que a instalação e manutenção dos seus diferentes produtos deve ser feita por um profissional qualificado, garantindo as condições de instalação descritas nas instruções de instalação e nas condições de funcionamento mencionadas na ficha técnica do produto. A Exporlux não pode ser responsabilizada por qualquer mal-entendido resultante do desconhecimento da metodologia geral de montagem, libertando a Exporlux de toda e qualquer responsabilidade em caso de uso inadequado ou por desrespeito às instruções de montagem do equipamento.

A Exporlux recomenda que, qualquer tecto falso destinado à colocação de produtos encastrados só deve ser realizada após os produtos a serem instalados terem sido escolhidos. A Exporlux sugere o mesmo procedimento para a abertura de fendas destinadas à instalação deste tipo de produtos, sugerindo que se reforce o tecto perto do entalhe de montagem e de acordo com as características do produto. O desempenho deste produto só será garantido se o seu manuseio, uso, instalação e manutenção forem realizados de acordo com as instruções fornecidas.

Se não estiver descriminado na ficha técnica, a temperatura máxima ambiente permitida é a +25°C. Valores nominais à temperatura ambiente (Ta=25°), e de acordo com EN60598 e EN 13032-1. Dadas as tolerâncias nos materiais, os dados de fluxo luminoso e consumo elétrico têm uma tolerância de +/-10%.

Os resultados fotométricos são obtidos testando um produto padrão de cada intervalo, em laboratório, em condições ideais.

Para obter as declarações de conformidade CE entre em contacto com a Exporlux.

### GARANTIA

Os nossos produtos estão cobertos por uma garantia de 2 anos a partir da data da sua entrega, para qualquer construção ou defeito de fabrico comprovados. As condições de transporte previstas, as condições de instalação descritas nas instruções de instalação e as condições operacionais mencionados na ficha técnica do produto estão também devidamente garantidas. Peças e componentes que necessitam de substituição devido ao desgaste normal estão excluídos desta garantia.

Os produtos devem ser instalados e mantidos por pessoal qualificado, de acordo com as instruções fornecidas, não podendo ser alterados ou reparados sem a nossa autorização prévia por escrito.

A Exporlux deve ser formalmente notificada de qualquer defeito que esteja coberto pela garantia. A Exporlux decide se repara ou substitui o produto por um igual ou por um produto equivalente. Isto está sempre sujeito às alterações decorrentes da evolução tecnológica e do processo de fabrico, no momento, a não ser que uma outra solução seja imposta por lei obrigatória.

Os produtos devolvidos só serão aceites até 10 dias após a sua entrega, e apenas para defeitos de fabricação que são confirmados pela fábrica, a menos que outras condições são estipuladas por lei.

Em caso de reclamação, mencionar o número na etiqueta autocolante branca colada no dispositivo.

### CONDIÇÕES DE VENDA

Todos os componentes eléctricos incluídos nos produtos são de alta qualidade. Recomendamos que todos os produtos sejam verificados na entrega! Se tiver dúvidas, entre em contato com a Exporlux.

### INSTALLATION AND MAINTENANCE

Exporlux suggests that the installation and maintenance of the different products must be performed by a qualified professional, ensuring the installation conditions described in the installation instructions and in the operating conditions mentioned in the product datasheet. Exporlux cannot be held responsible for any misunderstanding due to the unawareness of the general assembly method, freeing Exporlux from all liability if any inappropriate use or disregard for the assembling instructions of the equipment occurs. Exporlux recommends that any false ceilings intended for the placement of recessed products should only be erected after the products to be mounted have been chosen. Exporlux suggests the same for the opening of slots to mount this type of product. Reinforcing the ceiling close to the mounting cutout according to the product characteristics is strongly advised. The performance of this product will only be guaranteed if its handling, use, installation and maintenance are performed according to the supplied instructions.

If not specified in the technical sheet, the maximum allowed ambient temperature is +25°C. Nominal values at room temperature (Ta=25°), and according to EN60598 and EN 13032-1. Given the tolerances in the materials, the luminous flux and electrical consumption data have a tolerance of +/-10%.

Photometric results are obtained by testing a standard product from each interval, in the laboratory, under ideal conditions.

To obtain CE declarations of conformity, contact Exporlux.

### WARRANTY

Our products have a 2 year warranty from the date of their delivery, for any proven construction or manufacturing defect. Provided transportation conditions, installation conditions described in the installation instructions and the operating conditions mentioned in the product datasheet are duly guaranteed.

Parts and components requiring replacement due to normal wear are excluded from this warranty. The products must be installed and maintained by qualified personnel in accordance with the provided instructions, and they cannot be altered or repaired without our prior written permission. Exporlux must be formally notified of any defect that is found and covered by the warranty. Exporlux decides whether to repair or replace the product for a same or an equivalent product. This is always subject to the changes arising from the technological evolution of the manufacturing process at that time, unless another solution is imposed by mandatory law. Returned products will only be accepted within 10 days of their delivery, and only for manufacturing defects that are confirmed by the factory, unless other conditions are stipulated by mandatory law. In case of complaint, mention the number in the white label sticker presented on the device.

### SALES CONDITIONS

All electrical components included in the products are of high quality. We recommend that all products are checked on delivery! If you have questions, contact EXPORLUX.

## ICONOGRAFIA | ICONOGRAPHY



**Índice de Protecção - Grau de protecção dos invólucros de equipamentos eléctricos, contra corpos sólidos e contra líquidos.**  
Ingress of Protection - Degree of protection of electrical equipment enclosures, against solid bodies and against liquids.



**Índice de Resistência Mecânica - Identifica a resistência a impactos mecânicos externos.**  
Mechanical Resistance Classes - Resistance degree of the luminaires envelope against external mechanical impacts.



**Produto que está em conformidade com a directiva comunitária 2004/108/CE relativa à Compatibilidade Electromagnética e com a directiva 2006/95/CE para equipamentos de baixa tensão.**  
Product designed and manufactured in accordance with the Council directive 2004/108/CE concerning the Electromagnetic Compatibility and the Council directive 2006/95/CE for low-tension equipment.



**Classe I - Aparelhos de iluminação com terminal de terra de protecção.**  
Class I - Luminaires with protective earth terminal.



**Classe II - Aparelhos com duplo isolamento, ou com todas as partes metálicas isoladas. Não necessitam de ligação a terra de protecção.**  
Class II - Devices with double insulation, or all metal parts isolated. Not require earth terminal protection.



**Classe III - Aparelhos de iluminação que funcionam a uma tensão reduzida, igual ou inferior a 50V. Não necessitam ligação a terra de protecção.**  
Class III - Luminaires that work in a reduced voltage equal or less than 50V. Not require earth terminal protection.



**Branco Dinâmico - Luminária com regulação de temperatura de cor por meio de unidade de controlo.**  
Tunable White - Luminaire with light source colour temperature output control, via control unit.



**Unified Glare Rating (UGR) - é uma fórmula de avaliação unificada do brilho definido pelo relatório técnico da CIE 117-1995.**  
Unified Glare Rating (UGR) - is a unified glare assessment formula defined by the technical report of CIE 117-1995.



**Luminária com opção de montagem em linha.**  
Luminaire with in line mounting option.



**Aparelho equipado com balastro electrónico standard.**  
Device equipped with standard electronic ballast.



**Aparelho equipado com balastro electrónico de dimensões reduzidas.**  
Device equipped with electronic ballast of compact dimensions.



**Aparelho equipado com balastro electrónico standard que permite fazer a regulação de fluxo luminoso.**  
Device equipped with dimmable standard electronic ballast.



**Aparelho equipado com balastro electromagnético.**  
Device equipped with electromagnetic ballast.



**Aparelho equipado com fonte de alimentação DALI.**  
Device equipped with DALI power supply.



**Tempo de vida estimado do luminária.**  
Luminaire estimated lifetime.



**Número de Fases da luminária.**  
Luminaire Phase number.



**Encastrado chão, parede e tecto.**  
Floor, wall and ceiling recessed.



**Encastrado chão.**  
Floor recessed.



**Encastrado parede.**  
Wall recessed.



**Encastrado tecto.**  
Ceiling recessed.



**Saliente chão, parede e tecto.**  
Floor, wall and ceiling mounted.



**Encastrado parede e tecto.**  
Wall and ceiling recessed.



**Encastrado tecto e chão.**  
Ceiling and floor recessed.



**Encastrado chão e parede.**  
Floor and wall recessed.



**Luminária de calha.**  
Track luminaire.



**Saliente chão.**  
Floor mounted.



**Saliente parede.**  
Wall mounted.



**Saliente tecto.**  
Ceiling mounted.  
Sortant au plafond.



**Equipamento fornecido sem fonte de alimentação.**  
Equipment provided without power supply.



**Saliente parede e tecto.**  
Wall and ceiling mounted.



**Saliente tecto e chão.**  
Ceiling and floor mounted.



**Saliente chão e parede.**  
Floor and wall mounted.



**Aparelho equipado com conectividade Bluetooth®.**  
Device equipped with Bluetooth® connectivity.



**Suspensa.**  
Suspended.



**Luminária de pé para chão.**  
Stand-alone floor luminaire.



**Luminária de pé para mesa.**  
Stand-alone table luminaire.



**O produto não deve ser coberto com material isolante ou análogo.**  
Luminaire not suitable for covering with thermally insulating material.



**Aparelho equipado com condensador.**  
Device equipped with condenser.



**Resistência ao fio incandescente.**  
Glow wire resistance.



**Aparelho de exterior.**  
Outdoor device.



**Aparelho de interior.**  
Indoor device.



**Aparelho com equipamento de emergência.**  
Device with emergency equipment.

## SALVAGUARDA | DISCLAIMER

Todos os dados técnicos, incluindo dados sobre peso e dimensões, foram compilados com o devido cuidado. Excepto erros. As ilustrações de produto servem como exemplo e podem diferir do original. Reservamos o nosso direito a fazer alterações no âmbito da melhoria dos nossos produtos. Como resultado da constante evolução tecnológica, a EXPORLUX reserva-se o direito de alterar os dados constantes deste documento sem aviso prévio. Caso necessite de informação adicional, por favor contacte a EXPORLUX.

All technical data, including data on weight and dimensions, was compiled with the due care. Except errors. Product illustrations are used as examples and may differ from the original. We reserve the right to make changes in order to improve our products. As a result of the constant technological evolution, EXPORLUX reserves the right to change all data contained in this document without prior notice. If you need additional information, please contact EXPORLUX.

**ex.**

**CONTACTOS CONTACTS**

EXPORLUX Iluminação S.A.  
Rua da Arrota de Baixo 1007 - Covão  
ZI EN 1 Norte, Valongo do Vouga  
3750 - 802 Águeda | Portugal

Telf. +351 234 639 230  
Fax. +351 234 639 231

[exporlux@exporlux.pt](mailto:exporlux@exporlux.pt)

[www.exporlux.pt](http://www.exporlux.pt)  
[www.facebook.com/exporlux](https://www.facebook.com/exporlux)  
[www.instagram.com/exporlux](https://www.instagram.com/exporlux)

**EDIÇÃO PUBLISHING**  
EXPORLUX

**PRODUTO E DESENVOLVIMENTO PRODUCT AND DEVELOPMENT**  
EXPORLUX

**DESIGN GRÁFICO GRAPHIC DESIGN**  
EXPORLUX

ÁGUEDA, OUTUBRO 2021

DC 76/A

**ex.**